

## EC-029 WHISTLE MEC-029 WHISTLE

Parts List				
ITEM	DESCRIPTION	QTY	EC029	PART NUMBER
1	WHISTLE ASSEMBLY	1	1	402781
2	COLUMN	1	0	404635
2	COLUMN	0	1	Z006
	COLUMN END FITTING	1	0	M600
	-----HARDWARE COMPLETE-----	1	0	404634
	-----HARDWARE COMPLETE-----	0	1	404808
	EAGLE FASTENER	0	2	G000
	END CAP	1	1	G010
	PIPE MOUNT CAP - 1"	2	2	404154
	PIPE MOUNT BODY - 1"	2	2	404153
	#10 X 1/2" SHEET METAL SCREW	3	0	810062
	#10 X 2" WOOD SCREW	0	3	815507
	1/4" x 15/32" DRIVE RIVET	2	0	805303
	1/2" x 2 1/2" HEX HEAD BOLT	2	2	801225
	1/2" LOCKWASHER	2	2	817342
	3/8" x 2" SOCKET HEAD CAP SCREW SS	2	2	816087
	LABEL PACKAGE 2-5	1	0	E401E
	LABEL PACKAGE 2-5	0	1	H400E
	HOLE PLUG	0	16	G005G
	COLUMN END FITTING	0	1	Z600
	COLUMN FOOTING PIPE	0	1	401991

*Unless Otherwise Specified, All Units of Measure are Each*

*Items listed below Hardware Complete line are included with Hardware Complete Number*

**Warning: During Installation, Hardware And Small Parts Are Choking Hazards For Young Children. Store Unused Parts Appropriately Until Assembly Is Completed. Once Assembly Is Completed, Remove Any Unused Parts From The Play Environment And Dispose/Save Them In A Secure Location. Any bolt end protruding more than two full threads beyond the face of the nut causes risk of clothing entanglement.**

**Promptly cut-off flush, file smooth, and treat to prevent corrosion.**

**Note: Peen Tee-Nuts and Flatwashers to match radius of pipe after assembly is complete.**

**Note: Loctite (supplied by others) should be used on any non-patch hardware.**

### **INSTALLATION INSTRUCTIONS:**

1. Dig Footing Hole as shown in Elevation View.
2. For wood columns, insert Eagle Fasteners into appropriate holes. Apply Hole Plugs to remaining holes. See Detail D.
3. Attach (2) Pipe Mount Body to Column using 1/2" x 2 1/2" Hex Head Bolts and 1/2" Lock Washers. See Detail B.
4. Insert Pipe stubs on Whistle Ass'y. into the two Pipe Mount Bodies. See Detail B.
5. Insert (1) 3/8" x 2" Flat Head Socket Cap Screw through each of the two ea. Pipe Mount Caps and the holes in the Pipe Stubs on the Whistle Ass'y., and thread into the Pipe Mount Bodies. See Detail B.
6. Plumb and level the entire assembly and tighten all fasteners.

# EC-029 WHISTLE MEC-029 WHISTLE

- Attach Column End Fitting and End Cap to the top of the column using screws and drive rivets as shown in Details A OR C.
- When the structure is finished and satisfactory, eliminate sharp points and sharp edges (burring) on installed hardware like bolts, nuts, etc. Install resilient surfacing material within the use zone of play structure in accordance with ASTM specifications F1292 appropriate for the fall height of each structure. Refer to the *Safety Guidelines*.

**MAINTENANCE PROCEDURE:**

Periodically check hardware for tightness, and tighten as necessary. Always check all parts for breakage or wear, and immediately put equipment out of service until any faulty parts found are repaired or replaced. Also Check all metal parts for rust, paint loss and touch-up if necessary with paint. Check for welded areas and verify integrity. Check periodically resilient surfacing for appropriate depth and remove extraneous materials that could cause injury, infection, or disease. Maintain detailed installation, inspection, maintenance, and repair records for each public-use playground equipment.

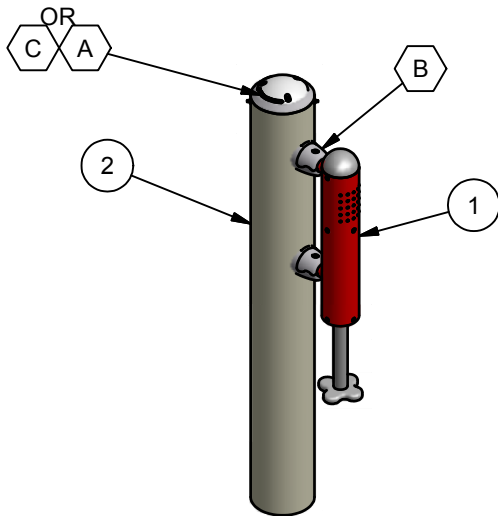

**FINISHED ASSEMBLY**

**CONCRETE REQUIRED**  
.07 CUBIC YARDS  
[.06 CUBIC METERS]

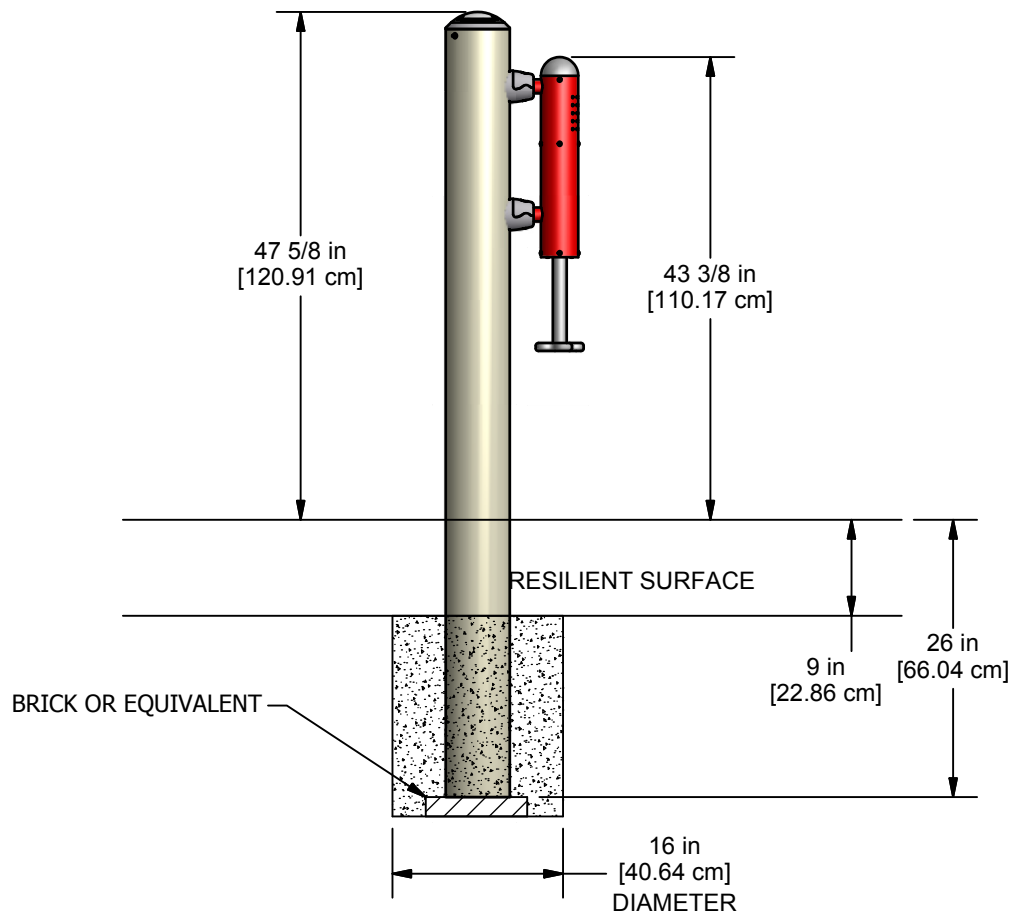

**ELEVATION VIEW**

 = INSTALLATION DETAIL

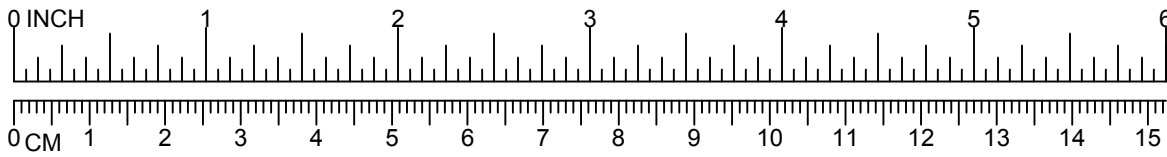

# EC-029 WHISTLE MEC-029 WHISTLE

Cross Recessed Flat  
Countersunk Head  
Tapping Screw Type  
AB - Type I (ANSI  
B18.6.4 - No. 10-16 x  
1/2)

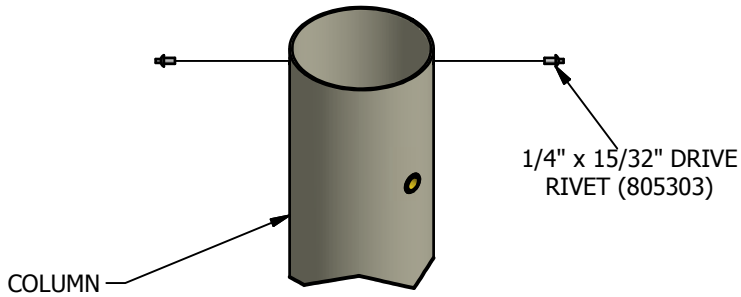
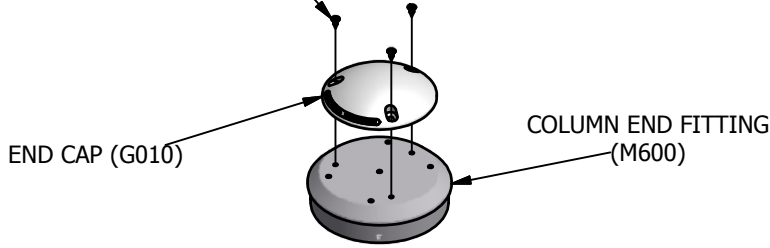

**A**

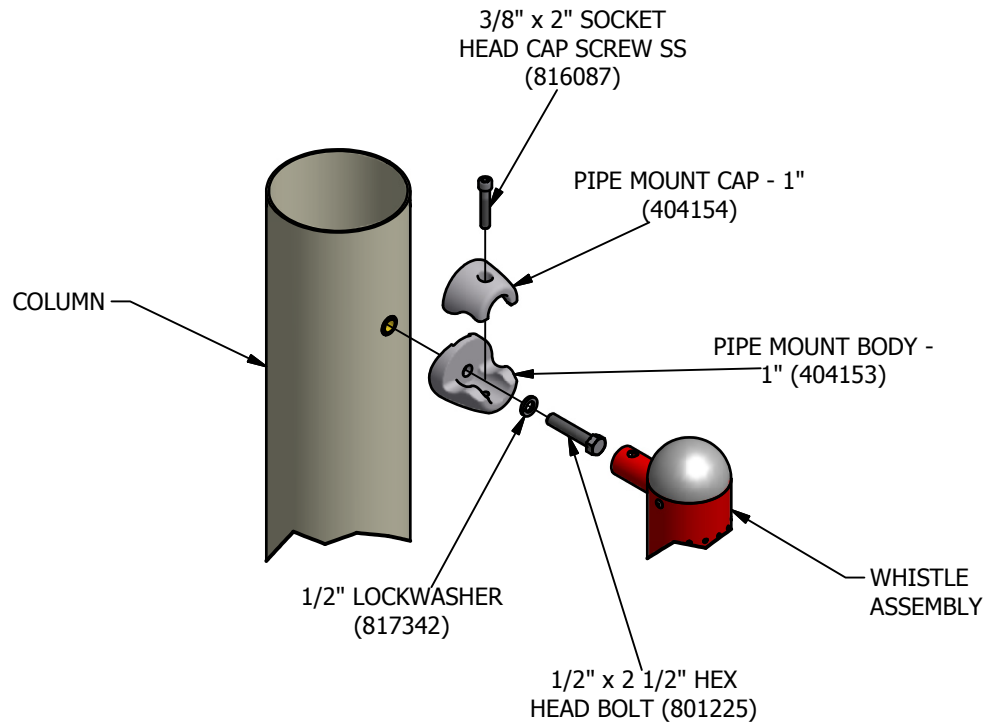

**B**

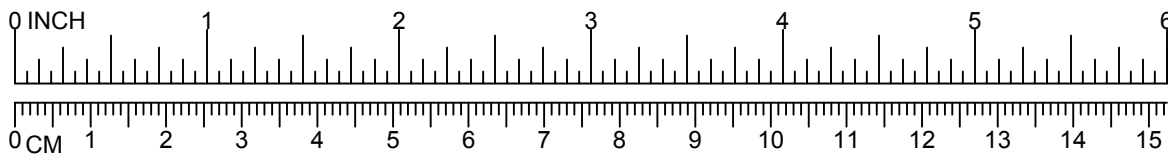

# EC-029 WHISTLE MEC-029 WHISTLE

