

EC-017 TODDLER PULL UP BAR

Parts List			
ITEM	DESCRIPTION	QTY	PART NUMBER
1	COLUMN, G-LAM - 4'	3	Z004
2	24" HANDGRIP	2	401691
	END CAP	3	G010
	-----HARDWARE COMPLETE-----	1	404638
	1/2" x 2 1/2" HEX HEAD BOLT	4	801225
	1/2" INTERNAL TOOTH LOCK WASHER	4	817201
	COLUMN END FITTING - WOOD	3	Z600
	10" PIPE	3	401991
	#10 x 2" WOOD SCREW	9	815507
	HOLE PLUG	20	G005G
	EAGLE FASTENER	4	G000
	12MM DO-NUT BASE	4	G034
	12MM DO-NUT CAP	4	G036
	LABEL PKG 6-23 MONTHS	1	H400I

*Unless Otherwise Specified, All Units of Measure are Each
Items listed below Hardware Complete line are included with Hardware Complete Number*

Warning: During Installation, Hardware And Small Parts Are Choking Hazards For Young Children. Store Unused Parts Appropriately Until Assembly Is Completed. Once Assembly Is Completed, Remove Any Unused Parts From The Play Environment And Dispose/Save Them In A Secure Location. Any bolt end protruding more than two full threads beyond the face of the nut causes risk of clothing entanglement. Promptly cut-off flush, file smooth, and treat to prevent corrosion.

Note: Peen Tee-Nuts and Flatwashers to match radius of pipe after assembly is complete.

Note: Loctite (supplied by others) should be used on any non-patch hardware.

INSTALLATION INSTRUCTIONS:

1. Dig Footing Hole as shown in Elevation View.
2. Insert columns into holes using brick or equivalent as support as shown in elevation view.
3. Attach End Fitting and End Cap to the top of the columns as shown in Detail A.
4. Drive Eagle Fasteners into holes that will receive handgrip assembly as shown in Detail B.
5. Attach Handgrip to columns as shown in Detail C.
6. Fill open column holes above the surfacing line with hole plugs as shown in Detail D.
7. Plumb and level the entire assembly and tighten all fasteners and pour concrete as shown in Elevation view.
8. When the structure is finished and satisfactory, eliminate sharp points and sharp edges (burring) on installed hardware like bolts, nuts, etc. Install resilient surfacing material within the use zone of play structure in accordance with ASTM specifications F1292 appropriate for the fall height of each structure. Refer to the *Safety Guidelines*.

MAINTENANCE PROCEDURE:

Periodically check hardware for tightness, and tighten as necessary. Always check all parts for breakage or wear, and immediately put equipment out of service until any faulty parts found are repaired or replaced. Also Check all metal parts for rust, paint loss and touch-up if necessary with paint. Check for welded areas and verify integrity. Check periodically resilient surfacing for appropriate depth and remove extraneous materials that could cause injury, infection, or disease. Maintain detailed installation, inspection, maintenance, and repair records for each public-use playground equipment.

EC-017 TODDLER PULL UP BAR

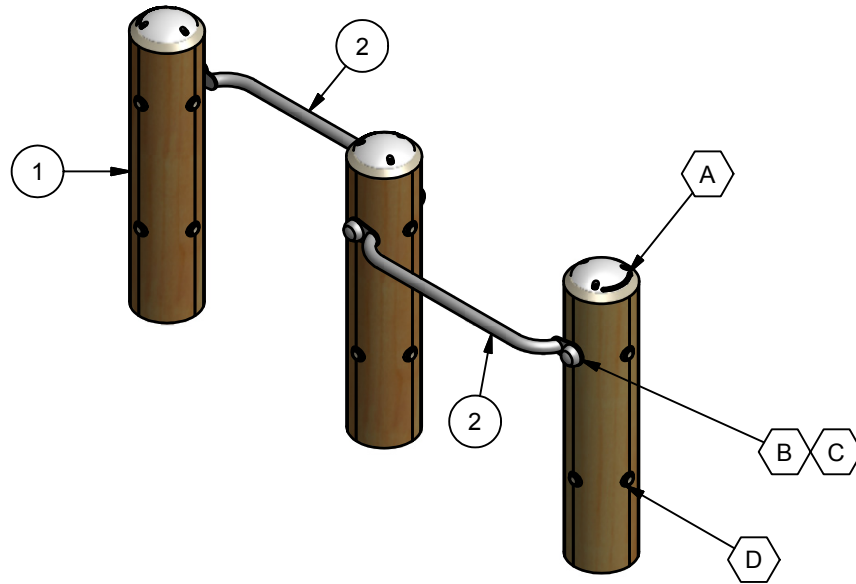

FINISHED ASSEMBLY

CONCRETE REQUIRED
 .15 CUBIC YARDS
 [.12 CUBIC METERS]

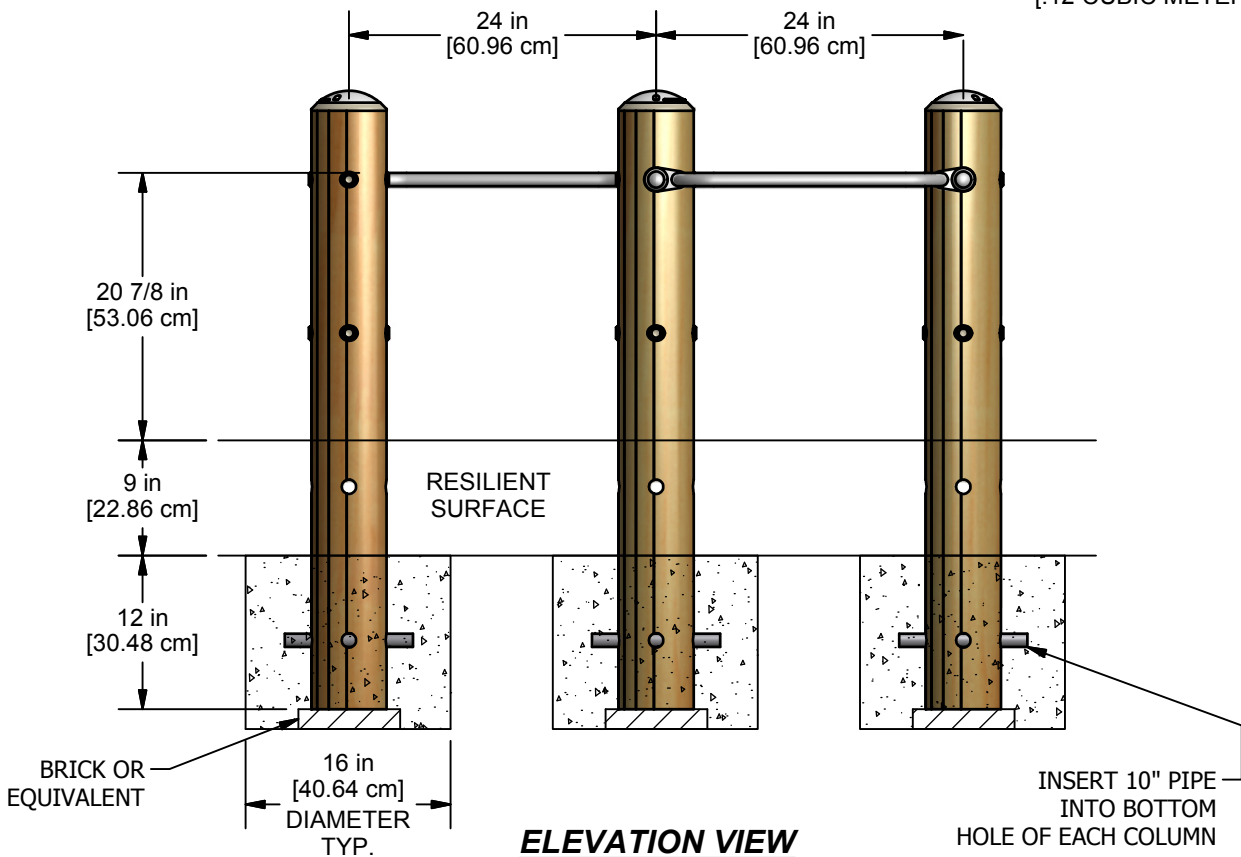

ELEVATION VIEW

= INSTALLATION DETAIL

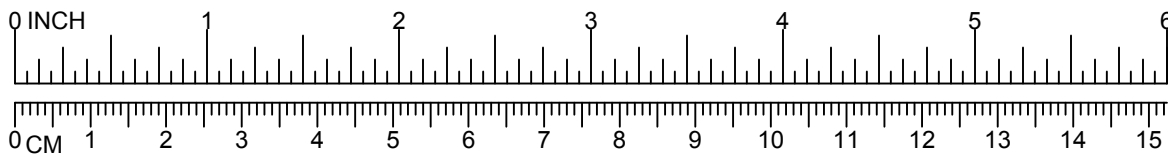

EC-017 TODDLER PULL UP BAR

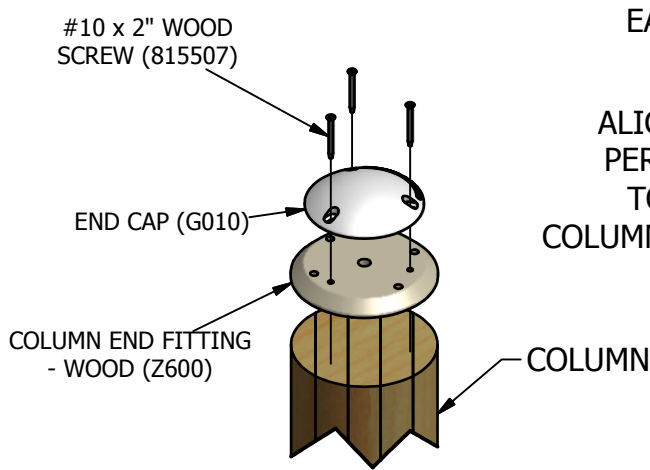

A

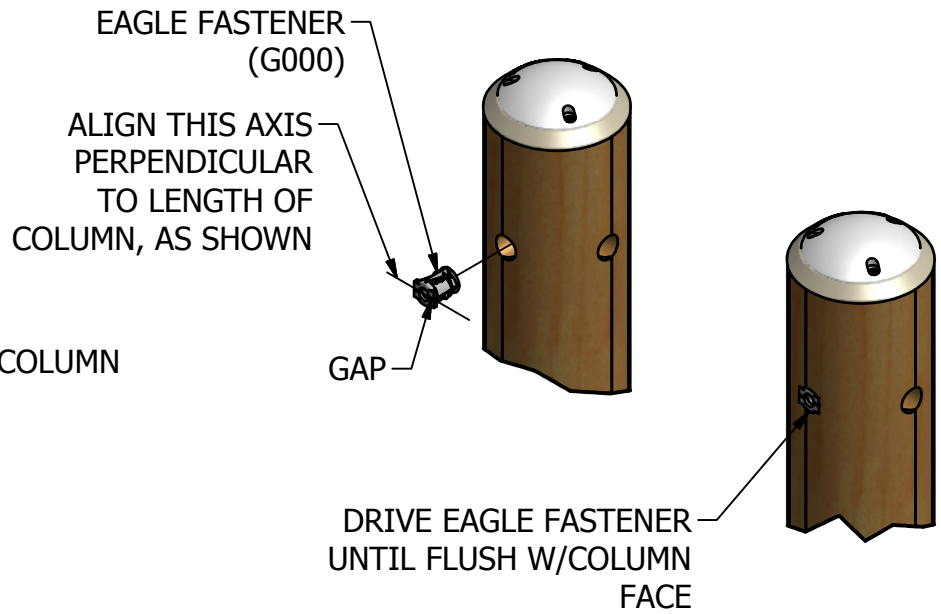

B

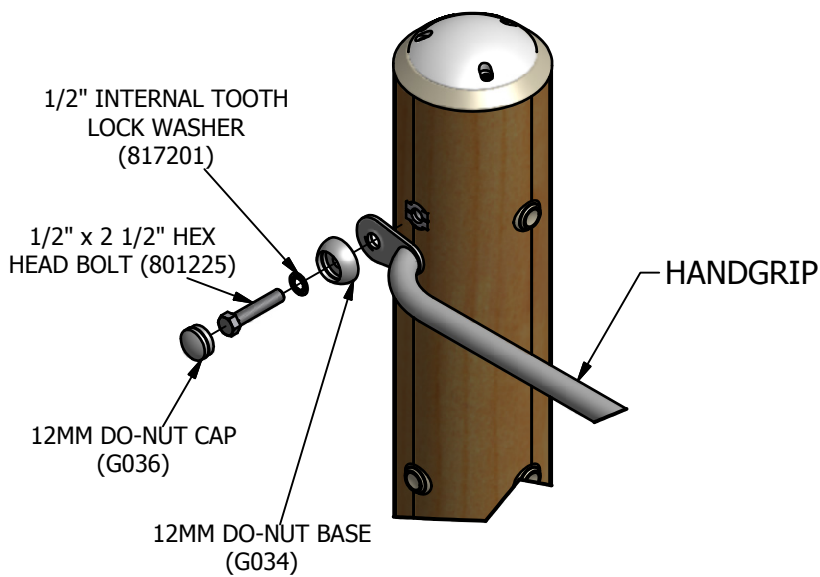

C

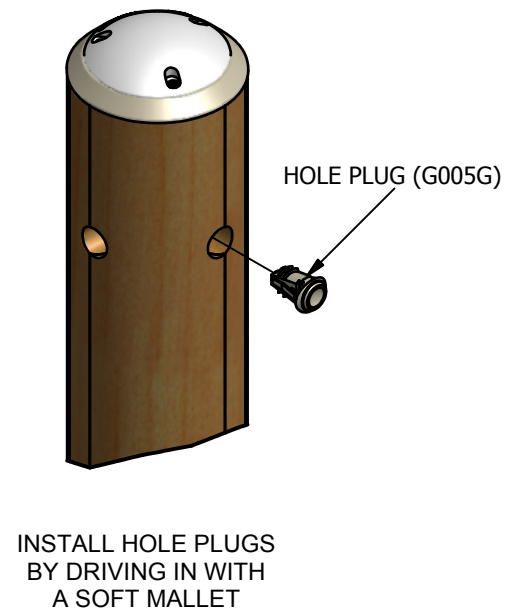

D