

Fabric Connection

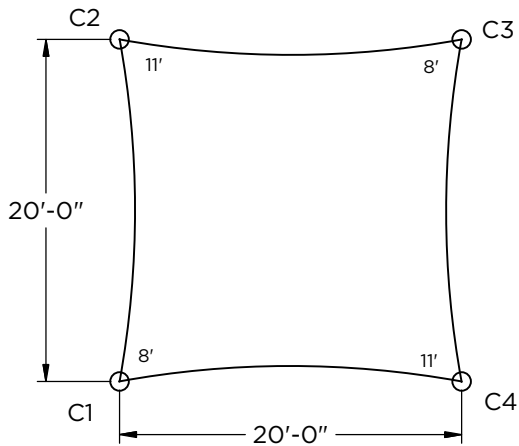

Plan View

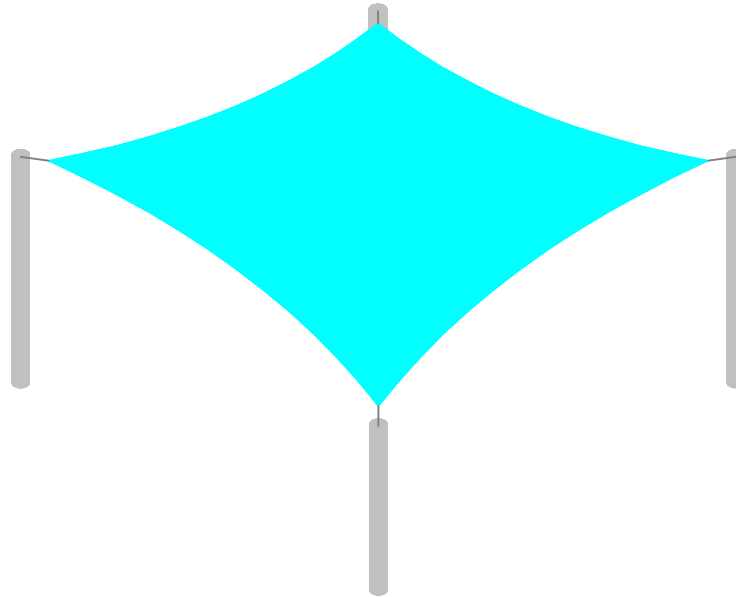
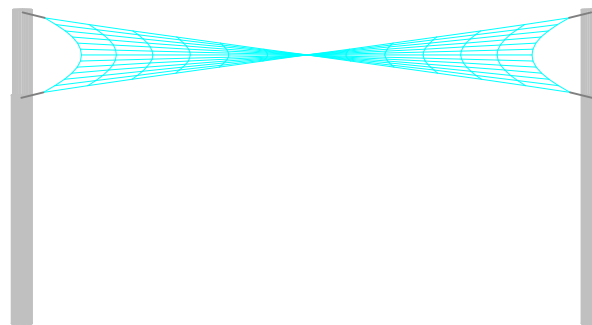

Side View

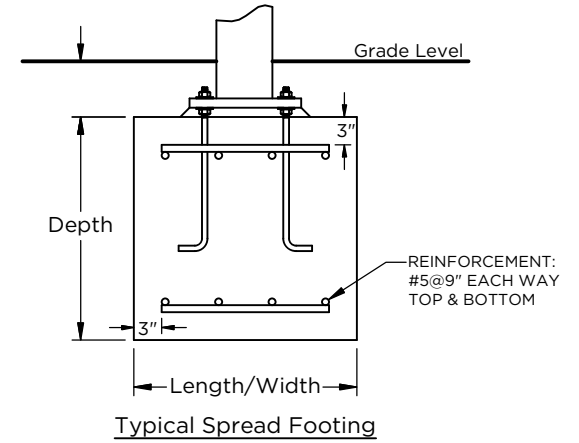

Typical Spread Footing

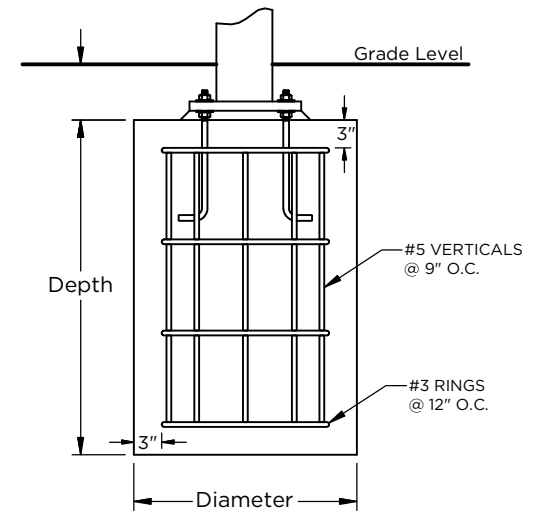

Typical Pier Footing

Column & Footing Schedule

Column ID	Column Size	Est. Footing Size	Est. Pier Footing Size
C1	6" Sch40	2.7' x 2.7' x 3.0'	3.2' Deep x Ø3.0'
C2	6" Sch40	2.8' x 2.8' x 3.0'	3.2' Deep x Ø3.0'
C3	6" Sch40	2.7' x 2.7' x 3.0'	3.2' Deep x Ø3.0'
C4	6" Sch40	2.8' x 2.8' x 3.0'	3.2' Deep x Ø3.0'

SHADE
BY SUPERIOR RECREATIONAL PRODUCTS

SHADE:
20' X 20' 8' EH HYPERBOLIC SAIL

SCALE
Not to Scale

These drawings are for reference only and should not be used as construction details. They show the general character and rough dimensions of the structural features. Superior Recreation Products is not responsible for deviation of final shade dimensions. All final dimensions must be verified in the field by the customer. Exact spans, fasteners, materials, and foundations can be determined by a licensed professional engineer upon request.

