

HEXAGON UMBRELLA SHADE

10' x 10' x 8'

MODEL #:
 HU101008IG (With Glide Elbows)
 HU101008IN (Without Glide Elbows)

REF.#	PART DESCRIPTION	QTY.
1	Ø5.0" Column - Surface Mount	1
2	Ø5.0" Crown - With Four Sockets	1
3	Ø2.5" Rafter - Swaged With Bracket	4
4	Strut - Rigid Fixed	4
5	Fabric - With Cable Insert	1
6	Frame Hardware Kit	1

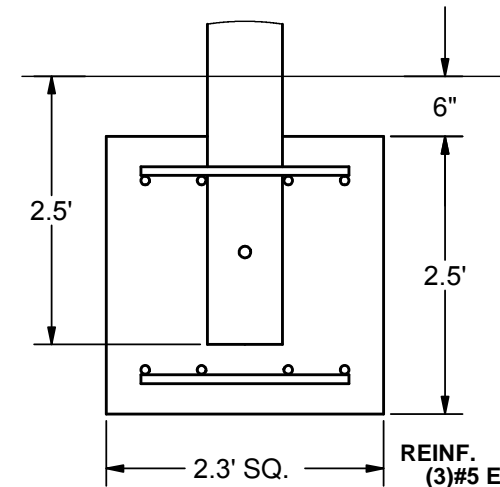
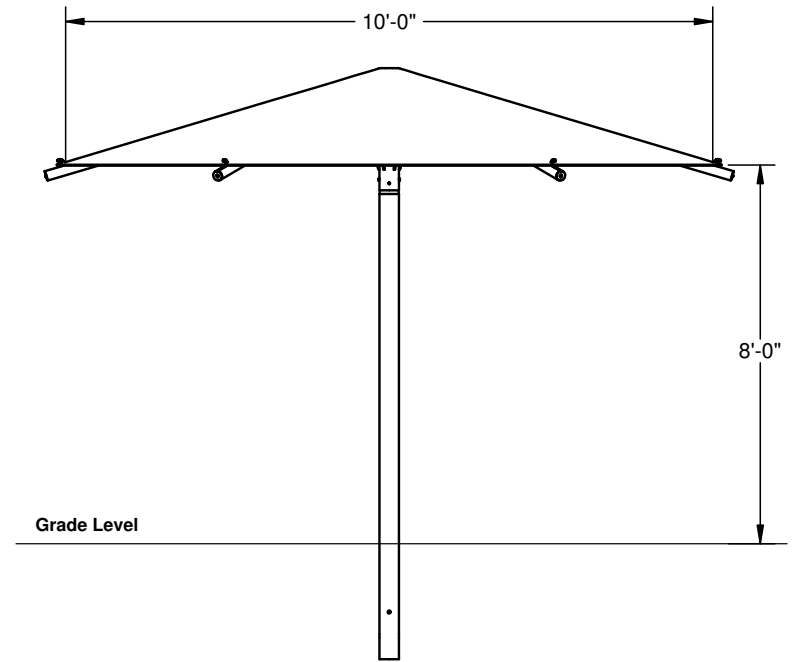

FOOTING DETAIL

REINF.
 (3)#5 EW
 Top And Bottom
 *Footing design based on 1500 PSF soil bearing pressure.



1050 Columbia Drive
 Carrollton, Georgia
 1.888.829.8997 | 770.834.2764 (f)

These drawings are for reference only and should not be used as construction details. Materials, fasteners, and foundations are subject to change if professionally sealed engineering drawings are required. Designed for 93 MPH Basic Wind Speed.